



fisufor[®] / fisufor[®] 3D

Bed joint reinforcement



DESCRIPTION

firufor® is a prefabricated bed joint reinforcement formed by two parallel longitudinal wires that are joined by a central wire. The central wire forms a truss structure and is soldered in the same point along the inside of the longitudinal wires. Therefore there is no overlap of the longitudinal and transverse wires, and the maximum thickness of the reinforcement is equal in diameter to the longitudinal wires.

The steel used in its manufacture is of in accordance with the standard EN 10020.

firufor® has the CE marking in accordance with the specifications of the standard EN 845-3; 2006+A1:2008.

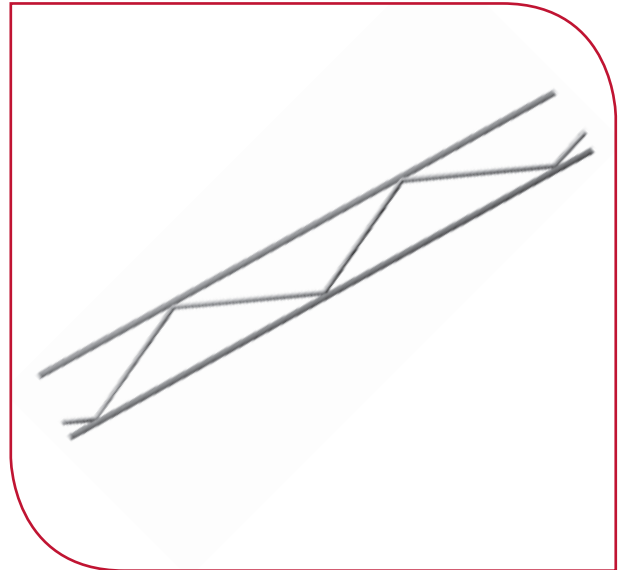

TYPES

I. ACCORDING TO THE TYPE OF WIRE



Smooth



Corrugated (Upon request)

II. ACCORDING TO THE PROTECTION AGAINST CORROSION

- **firufor®** G, manufactured with steel wire given a zinc galvanised coating with a minimum level of 70 gr/m² in accordance with standard EN 10244.
- **firufor®** I, manufactured with stainless steel wire in accordance with Standard EN 10088.
- **firufor®** E, manufactured with steel wire given a zinc galvanized coating with a minimum level of 70 gr/m² in accordance with EN 10244 and subsequent epoxy coating of at least 80 µm in accordance with standard EN 10245.

III. ACCORDING TO DIMENSIONS

Diameter of the wire:

firufor® reinforcement is manufactured with longitudinal wires that have diameters of 3, 4 and 5mm and transverse wires with diameters of 3 and 3.7 mm.

Width of the reinforcement:

firufor® bed joint reinforcement comes in widths ranging from a minimum of 30 mm up to a maximum of 250 mm.

DIMENSIONS

TYPES OF fisufor®						
NAME/NUMBER	WIDTH (mm)	Ø wire longitudinal (mm)	Ø wire transversal (mm)	TOTAL AREA (mm ²)	WEIGHT (kg)	LENGTH (mm)
FISUFOR/Z 3050 Z	50	3	3	21	0,51	3050
FISUFOR/Z 3080 Z	80	3	3	21	0,52	3050
FISUFOR/Z 3100 Z	100	3	3	21	0,53	3050
FISUFOR/Z 4030 Z	30	4	3,7	34	0,86	3050
FISUFOR/Z 4050 Z	50	4	3,7	34	0,87	3050
FISUFOR/Z 4080 Z	80	4	3,7	34	0,88	3050
FISUFOR/Z 4100 Z	100	4	3,7	34	0,89	3050
FISUFOR/Z 4150 Z	150	4	3,7	34	0,92	3050
FISUFOR/Z 5050 Z	50	5	3,7	48	1,20	3050
FISUFOR/Z 5200 Z	200	5	3,7	48	1,30	3050
FISUFOR/Z 5250 Z	250	5	3,7	48	1,35	3050
FISUFOR/E 3050 E	50	3	3	21	0,52	3050
FISUFOR/E 3080 E	80	3	3	21	0,53	3050
FISUFOR/E 3100 E	100	3	3	21	0,54	3050
FISUFOR/E 4030 E	30	4	3,7	34	0,87	3050
FISUFOR/E 4050 E	50	4	3,7	34	0,88	3050
FISUFOR/E 4080 E	80	4	3,7	34	0,89	3050
FISUFOR/E 4100 E	100	4	3,7	34	0,90	3050
FISUFOR/E 4150 E	150	4	3,7	34	0,93	3050
FISUFOR/E 5050 E	50	5	3,7	48	1,22	3050
FISUFOR/E 5200 E	200	5	3,7	48	1,31	3050
FISUFOR/E 5250 E	250	5	3,7	48	1,37	3050
FISUFOR/I 4030 I	30	4	3,7	34	0,87	3050
FISUFOR/I 4050 I	50	4	3,7	34	0,87	3050
FISUFOR/I 4080 I	80	4	3,7	34	0,89	3050
FISUFOR/I 4100 I	100	4	3,7	34	0,90	3050
FISUFOR/I 4150 I	150	4	3,7	34	0,93	3050
FISUFOR/I 5050 I	50	5	3,7	48	1,21	3050
FISUFOR/I 5200 I	200	5	3,7	48	1,31	3050
FISUFOR/I 5250 I	250	5	3,7	48	1,36	3050

PRESENTATION

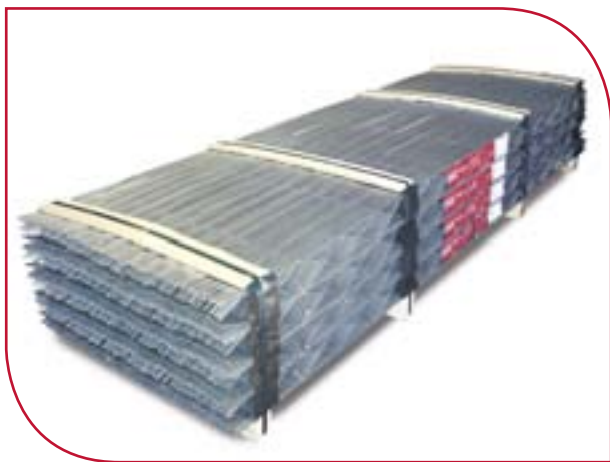

- Piece length of 3050 mm.
- Packets of 25 units.
- Pallets of 40 packets (1000 units of 3050 mm)
- Each packets contains ID label with description of the product, its barcode and batch number.

DESCRIPTION

firufor® 3D is a prefabricated bed joint reinforcement formed by two parallel longitudinal wires that are joined by a central wire. The central wire forms a truss structure and is soldered in the same point along the inside of the longitudinal wire. Therefore there is no overlap of the longitudinal and transverse wires, and the maximum thickness of the reinforcement is equal in diameter to the two longitudinal wires.

The steel used in its manufacture is of in accordance with the standard EN 10020.

firufor® 3D This reinforcement is characterized by the incorporation of separators along the transverse wires; the separators are plastic with cylindrical geometry which ensures the minimum coating of mortar, allowing proper implementation and maximum working potential.

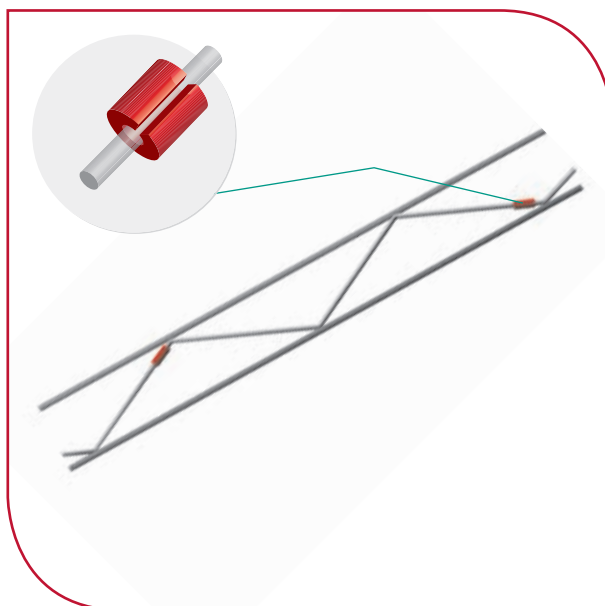

TYPES

I. ACCORDING TO THE TYPE OF WIRE



Smooth



Corrugated (upon request)

II. ACCORDING TO THE PROTECTION AGAINST CORROSION

- **firufor® 3D G**, manufactured with steel wire given a zinc galvanised coating with a minimum level of 70 gr/m² in accordance with standard EN 10244.
- **firufor® 3D I**, manufactured with stainless steel wire in accordance with standard EN 10088.

- **firufor® 3D E**, manufactured with steel wire given a zinc galvanized coating with a minimum level of 70 gr/m² in accordance with EN 10244 and subsequent epoxy coating of at least 80 µm in accordance with standard EN 10245.

III. ACCORDING TO DIMENSIONS

Diameter of the wire:

firufor® 3D reinforcement is manufactured with longitudinal wires that have a diameter of 3.7 and 5 mm and transverse wires with diameters of 3 and 3.7 mm.

Width of the reinforcement:

firufor® 3D bed joint reinforcement comes in widths ranging from a minimum of 50mm up to a maximum of 250 mm.

DIMENSIONS

TYPES OF fisufor 3D[®]						
NAME/NUMBER	WIDTH (mm)	Ø wire longitudinal (mm)	Ø wire transversal (mm)	TOTAL AREA (mm ²)	WEIGHT (kg)	LENGTH (mm)
FISUFOR 3D 4050 Z	50	3,7	3	28,56	0,688	3050
FISUFOR 3D 4080 Z	80	3,7	3	28,56	0,696	3050
FISUFOR 3D 4100 Z	100	3,7	3	28,56	0,703	3050
FISUFOR 3D 4150 Z	150	3,7	3	28,56	0,724	3050
FISUFOR 3D 4200 Z	200	3,7	3	28,56	0,751	3050
FISUFOR 3D 5200 Z	200	5	3,7	49,99	1,300	3050
FISUFOR 3D 5250 Z	250	5	3,7	49,99	1,347	3050
FISUFOR 3D 4050 E	50	3,7	3	30,46	0,698	3050
FISUFOR 3D 4080 E	80	3,7	3	30,46	0,706	3050
FISUFOR 3D 4100 E	100	3,7	3	30,46	0,714	3050
FISUFOR 3D 4150 E	150	3,7	3	30,46	0,735	3050
FISUFOR 3D 4200 E	200	3,7	3	30,46	0,762	3050
FISUFOR 3D 5200 E	200	5	3,7	50,95	1,313	3050
FISUFOR 3D 5250 E	250	5	3,7	50,95	1,361	3050
FISUFOR 3D 4050 I	50	3,7	3	28,56	0,688	3050
FISUFOR 3D 4080 I	80	3,7	3	28,56	0,696	3050
FISUFOR 3D 4100 I	100	3,7	3	28,56	0,703	3050
FISUFOR 3D 4150 I	150	3,7	3	28,56	0,724	3050
FISUFOR 3D 4200 I	200	3,7	3	28,56	0,751	3050
FISUFOR 3D 5200 I	200	5	3,7	49,99	1,300	3050
FISUFOR 3D 5250 I	250	5	3,7	49,99	1,347	3050

Other widths available upon request.

PRESENTATION



- Piece length of 3050 mm.
- Packets of 25 units.
- Pallets of 40 packets(1000 units of 3050 mm)
- Each packet contains ID label with description of the product, its barcode and batch number.

REQUIREMENTS OF THE MASONRY REINFORCEMENT

A reinforced wall is considered to be of “composite material” which has attributed properties that improve its mechanical behavior.

MECHANICAL RESISTANCE

The mechanical resistance of traction of steel is a basic benefit to be able to measure the masonry reinforcement’s structural use according to forces resulting from the analysis.

The value of the mechanical resistance is obtained through testing and must be declared in the regulatory CE marking, so that this provision is guaranteed by the manufacturer.

From the viewpoint of the structural analysis, the value of the mechanical resistance of the masonry reinforcement is a fundamental parameter. However, the required minimum quantities which are essential

DUCTILITY

Ductility is probably the most important requirement of the masonry reinforcement, when used with structural function. Ductility is the property of a material to acquire very high deformations before breaking, just for tension values next to breakage. This particular property is what defines a structural material.

The ductility of the masonry reinforcement is measured by the value of the maximum deformation in breakage, and is obtained by standardized tensile tests, so it is guaranteed by the manufacturer. A

CORROSION RESISTANCE

The corrosion resistance of the masonry reinforcement is a prerequisite for the durability of the element of the reinforced masonry. Even in situations of non-structural use of masonry reinforcement, by the mere fact of being embedded in the wall of the masonry, it must be corrosion resistant. This is due to the phenomenon of oxidation of steel is expansive, and the beginning of this process at any point on the masonry reinforcement

But this only it is correct if the basic requirements are the following:

when considering the reinforced masonry of a composite material, forces the reinforcement to be very thinly spread out, so the efforts allocated to this element, in most cases, are very modest. A mechanical resistance value of the steel between 500 N/mm² y 600 N/mm² is sufficient so that the criterion of minimal quantity usually dominates in the measurement, so that the steel never has to exhibit all of its mechanical resistance. Using steels with increased resistance, it is not only wasteful, but it may be counterproductive because it has an effect of decline in the following basic requirements.

value of maximum deformation in breakage around 18% provides the sufficient ductility to consider the masonry reinforced with a quantity of no less than the minimum, for a structural material with ductile behavior. In general, the ductility is a property contrary to the high mechanical resistance. The steels with high resistance have a behavior less ductile, by what the optimal values of resistance identified above constitute an upper limit (not less, as it might appear) if you want to simultaneously meet the requirement of ductility.

produces a change in volume that will be damaging and disintegrating to the wall.

The requirement of corrosion resistance is obtained by protecting the masonry reinforcement through an appropriate finishing. There are different coatings for the reinforcement, according to the aggressive conditions of exposure of the element of reinforcement.

In general, for reinforcement in non-aggressive

interior environment, or masonries with a covered exterior facade, it is enough to use a masonry reinforcement coating with galvanized finish. For external faces with the bricks exposed, if they are not close to a marine environment, the appropriate

ADHESION

The adhesion between the masonry reinforcement and the mortar is necessary for a compound behavior, although their significance is different depending on the geometric configuration of the masonry reinforcement.

Masonry reinforcement that has a configuration deformable in its plane, for example in the ladder type, in the same way that this occurs when using the technique of reinforced concrete, specifically the adherence with the mortar is essential for providing the proper transmission of forces.

On the contrary, masonry reinforcement that has a configuration in the truss type is in-deformable along

its plane, which means that they can transmit forces of horizontal bending themselves, regardless of the presence of the mortar that surrounds them.

The adhesion is only essential at the ends of the masonry reinforcement, from the last part of the truss. Even in these areas, the adhesion that is required is relatively small, since the technique of masonry reinforcement is achieved with the reinforcement widely distributed and very small in diameter, so that the forces to convey are very modest.

The adhesion in the ends is ensured through tests, so this benefit is declared in the regulatory CE marking, with which the manufacturer is committed to.

COATING

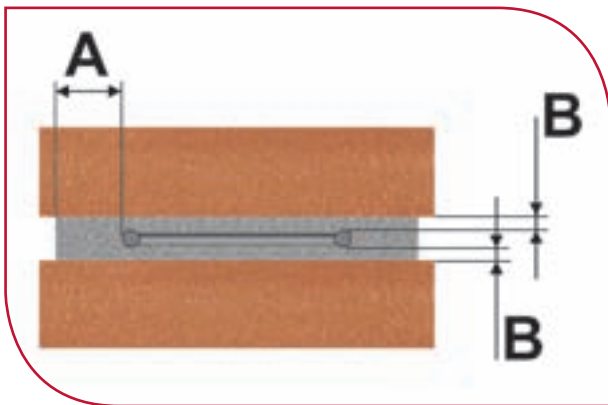

The coating with mortar of the masonry reinforcement is a fundamental requirement to ensure the protection of the steel from corrosion. Therefore, when it comes to getting this benefit, the conditions of coating have different importance according to the finishing of the masonry reinforcement. The stainless steel masonry reinforcement coating has a minimal risk of corrosion and, consequently, their conditions of coating are less demanding than the other types of coating such as epoxy finish and even less so corresponding to the galvanized finish. However, the coating is also an essential requirement for the proper transmission of forces of adhesion in the overlap areas and this is common for all the masonry reinforcements with

A: The masonry reinforcement **fisufor®** will be placed centered on the structure leaving a minimum of 15 mm coating of mortar between the longitudinal wire and the outer edge of the joint.

B: The thickness of mortar above and below the masonry reinforcement shall be at least 5 mm.

structural use, independently of the type of finish. In order to achieve this provision, you must respect the minimum thickness of coating, both upper and lower, as well as lateral.

Side coating in the areas of overlap is essential so that there is the transmission of efforts between the piece of reinforcement and the adjoining one, this circumstance must be taken into account when choosing the width of the reinforcement so that it is appropriate to the thickness of the wall. If the reinforcement does not have a specific design for the overlap, you must limit your width to allow the correct covering along the reinforcement longitudinally.

HOW TO CHOOSE THE RIGHT WIDTH OF THE MASONRY REINFORCEMENT?

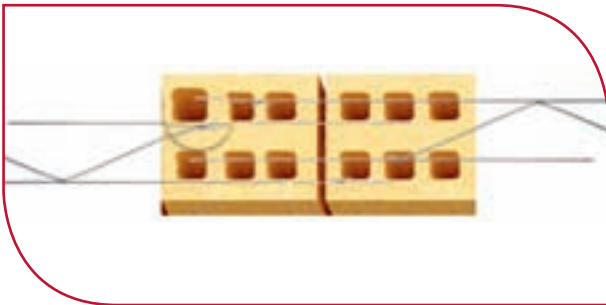

N - NOMINAL WIDTH OF THE MASONRY REINFORCEMENT
 R - TRUE WIDTH OF THE REINFORCEMENT = N + 20 mm + Ø OF THE LONGITUDINAL WIRE.

To guarantee the minimum lateral coating of the masonry reinforcement when overlapping, the most appropriate is wider reinforcement that meets this requirement: total width of the mortar \geq that R + 30 mm.

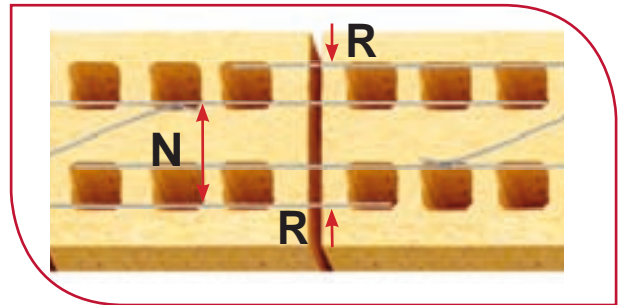

Example: For a wall of 11,5 cm and a width of mortar of 11 cm, the better masonry reinforcement would be:
 Total width of the mortar = N + 20 mm + Ø + 30 mm.
 $110 = N + 20 + 4 + 30$
 $N = 110 - 54$
 $N = 56 \text{ mm} \sim$ masonry reinforcement of 50 mm width
 The right masonry reinforcement for a wall of 11,5 cm has a width of 50 mm.

OVERLAPPING

The overlap between adjacent masonry reinforcement is a prerequisite for the transmission of forces of horizontal bending in masonry reinforcement with a structural function.

The correct overlap requires not only a certain length which is a function of the diameter and strength of the masonry reinforcement, but one sufficient side coating to ensure precise adherence

for the transmission.

In general, the masonry reinforcements on the market need manipulation when used to get the correct length of overlap and a very meticulous execution. If these conditions cannot be guaranteed, it is reckless to assign to the masonry reinforcement a structural provision.

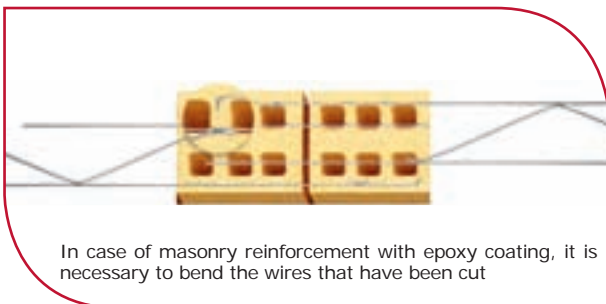
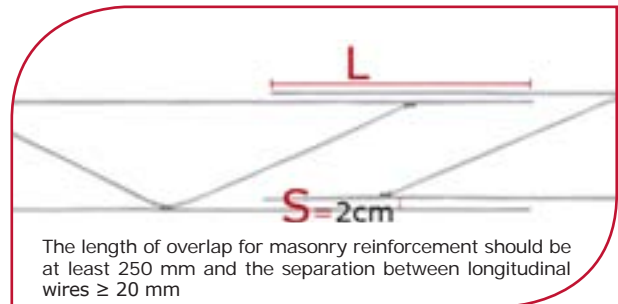
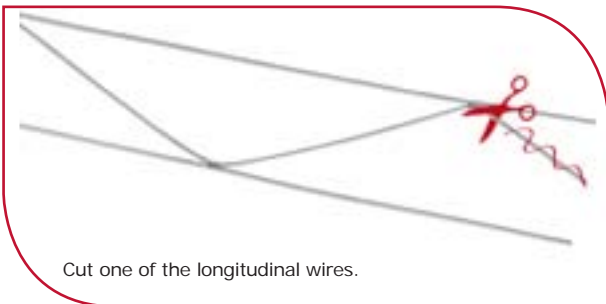

In accordance with the specifications of the current standards, a correct overlap between truss type masonry reinforcement should meet the following requirements:

- Length of overlap: 250 mm (0,6 the distance of the pitch of the cross-wires).
- Horizontal distance between overlapped wires: 20 mm.
- Lateral coating of the wires that have been cut: 30 mm (except stainless steel wires).

IMPORTANT: At the ends of the reinforcement for structural use it must meet the three requirements: ADHESION, MORTAR COATING and OVERLAP.

PLACEMENT

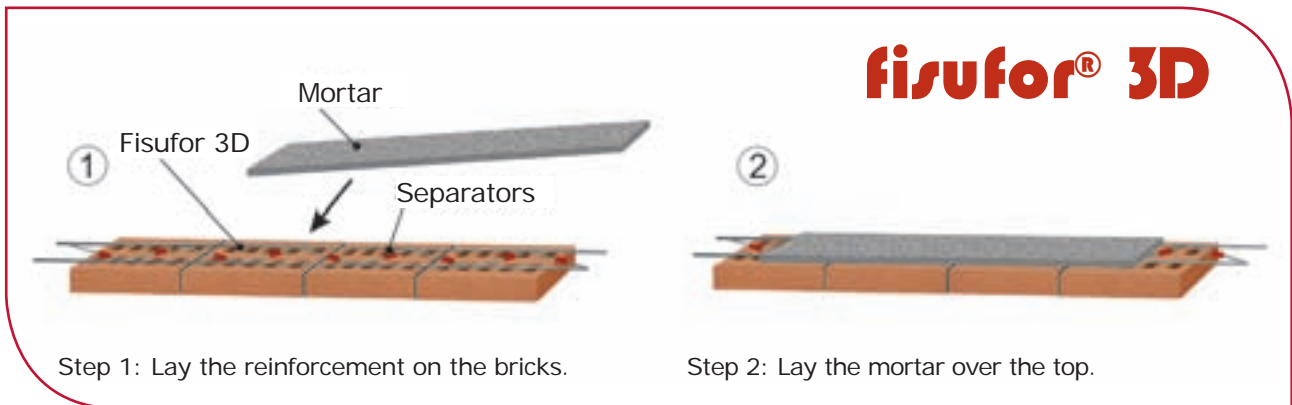
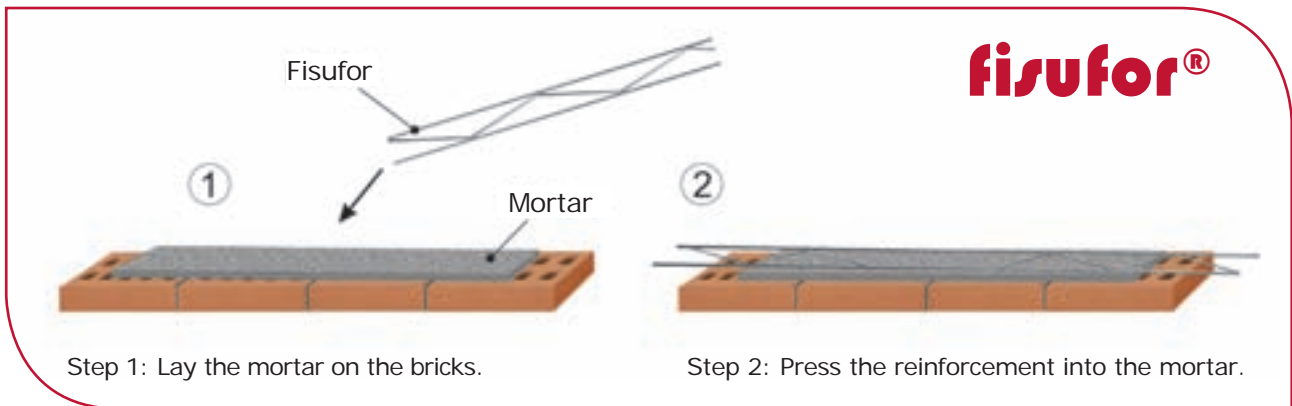

ADVANTAGES **fisufor[®] 3D**

- It facilitates the best implementation of work by ensuring the minimum covering of mortar

between the reinforcement and the masonry.



- Without correct mortar cover.

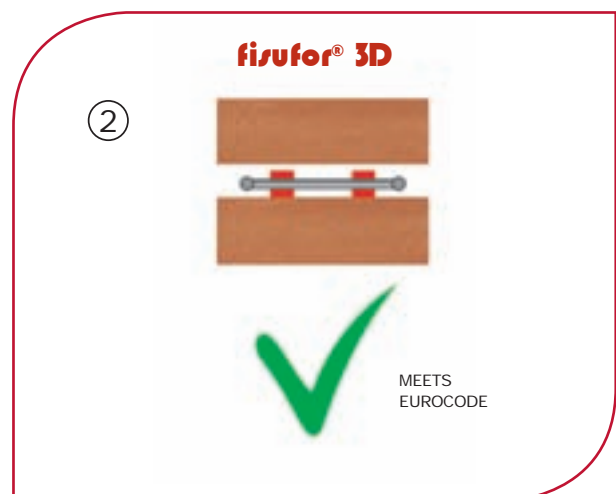

- With correct mortar cover.

INDEX

ADVANTAGES AND APPLICATIONS

1. CRACKING CONTROL

1.1. HOMOGENEOUS REINFORCEMENT

1.2. LOCALIZED REINFORCEMENT

1.2.1. START OF FOUNDATIONS

1.2.2. LINTELS AND SILLS

1.2.3. STARTING ON FLOORS AND BEAMS

1.2.4. ROOF PARAPETS

1.2.5. POINT LOADS

1.2.6. MEETINGS, WALL CORNERS AND "T" POINTS

2. USE AS STRUCTURAL REINFORCEMENT

2.1. REINFORCEMENT USE OF THE GHAS SYSTEM

2.2. STACK BONDED MASONRY

2.3. DOUBLE WALLS

2.4. LARGE CONCRETE BLOCK WALLS

2.5. INTERIOR PARTITIONS

2.6. MOVEMENT JOINTS

2.7. EXECUTION OF LINTELS

ADVANTAGES AND APPLICATIONS

1. CRACKING CONTROL

1.1 HOMOGENEOUS REINFORCEMENT

Consists of placing the masonry reinforcement continually in the wall throughout the large part of the...sonry.

The homogeneous protection offered by **fisufor®** prevents the risk of cracking in the masonry, which could be caused by local effects that cannot be considered in the planning. This property is recognized in the Eurocode 6

part 1-1 (article 8.2.3).

The homogenous protection needed to prevent cracking requires an amount of steel greater than 0.03% of the vertical section of the wall and distance between reinforced rows of 60 cm maximum. **fisufor®** of 4mm thickness can be used in walls not exceeding 190 mm and **fisufor®** 5 mm in all other cases.

1.2 LOCALIZED REINFORCEMENT

Since the cracking in masonries is normally produced in the same predetermined points, these points can be established and reinforced,

making reinforcing an economical solution for where cracking is most likely to occur (lintels, sills, corners, overhangs)

1.2.1. START OF FOUNDATIONS

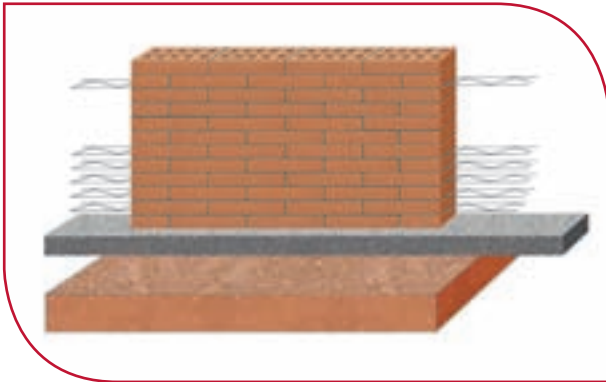

The use of **fisufor®** masonry reinforcement avoids the risk of cracking caused by possible differential settlement in the ground. We recommend the assembly in the five first level layers in the foundation.

1.2.2. START OF FLOORS AND BEAMS

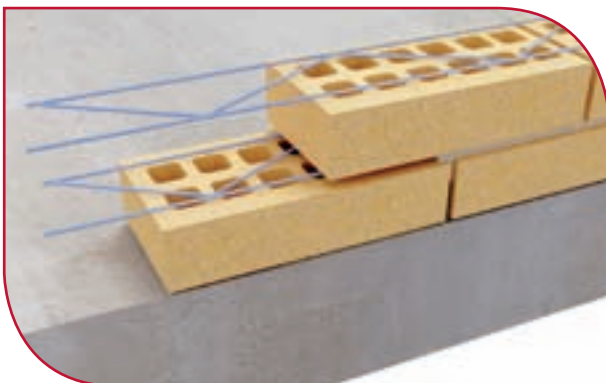

It will be possible for **fisufor®** reinforcement to prevent the risk of cracking generated by bending due to the burden of slabs and beams. It is recommended you have reinforcement in the first 3 layers.

1.2.3. LINTELS AND SILLS

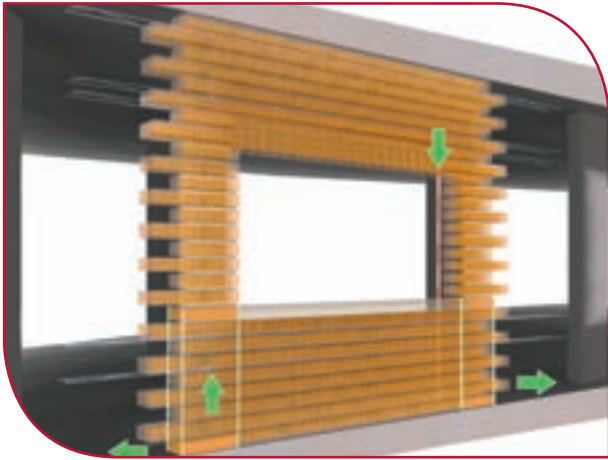

To avoid the appearance of cracks produced by stress concentrated at windows and doors, it is essential to reinforce them with **fisufor**[®]. The minimum amount of reinforcement recommended is; reinforcement on the last row underneath the parapet, and two reinforcements on the first rows over the lintel of the opening. **fisufor**[®] reinforcement must exceed at least 50 cm either side of the opening.

1.2.4. ROOF PARAPETS

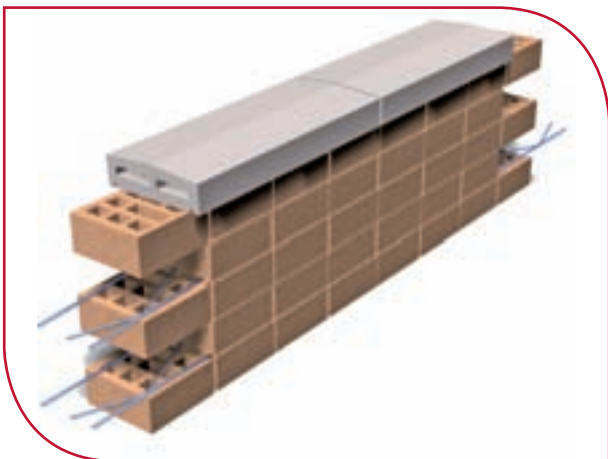

It is recommended when building that the first two rows and every 40 cm are reinforced to avoid possible cracking produced by thermal expansion and slab bending.

For this application it is desirable to consult with our **technical department** as there may be stability problems and the needs for joint movement.

1.2.5. POINT LOADS

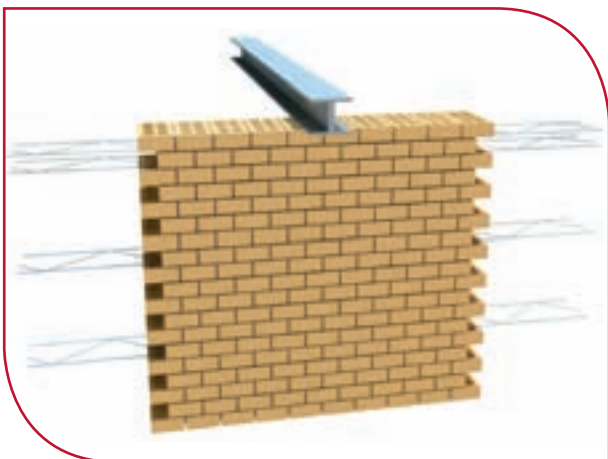

We recommend the use of **fisufor**[®] to prevent cracking problems and tensile stresses, by the assembly of four rows located below the support.

1.2.6. MEETINGS, WALL CORNERS AND "T" POINTS

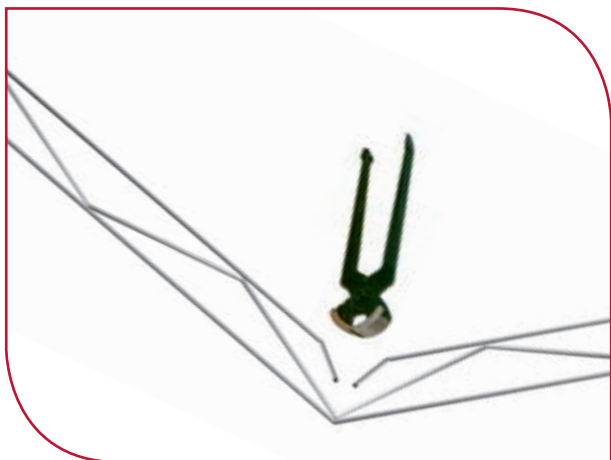

For correct placement of the reinforcement to execute corners, it is necessary to cut one of the wires.



Installation is recommended every 40 cm to avoid possible cracking. Likewise, **fisufor[®]** allows the execution of corners without bracing. The property of uniting meetings between reinforced walls is recognized in Eurocode 6 part 2.

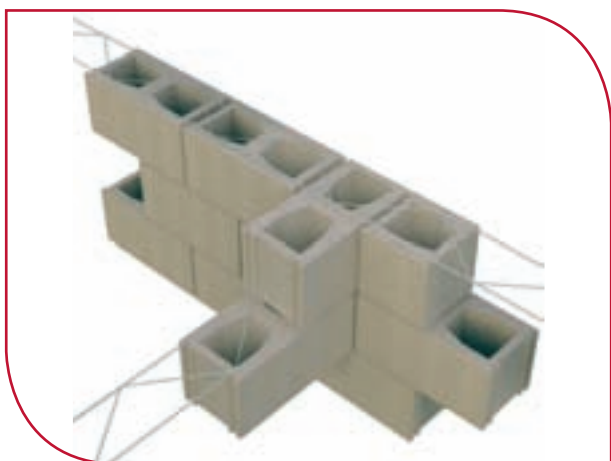

It is recommended to tie the two walls with **fisufor[®]** reinforcement that is placed every 40 cm on the two walls. The reinforcement forming symmetrical corners should alternate rows.

2. USE AS STRUCTURAL REINFORCEMENT

2.1 REINFORCEMENT USES OF THE GHAS SYSTEM

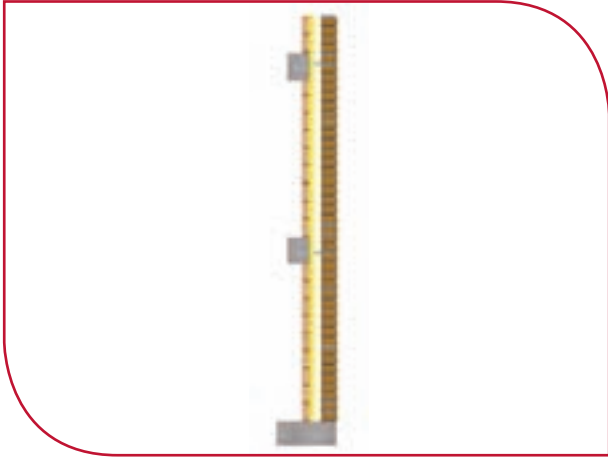

Application in conjunction with **geoanc®** anchorage in the **GHAS® system** for self-supporting or ventilated facades.

For a proper calculation it is essential to contact our **technical department**.

- Consult the specific catalogue.

2.2 STACK BONDED MASONRY

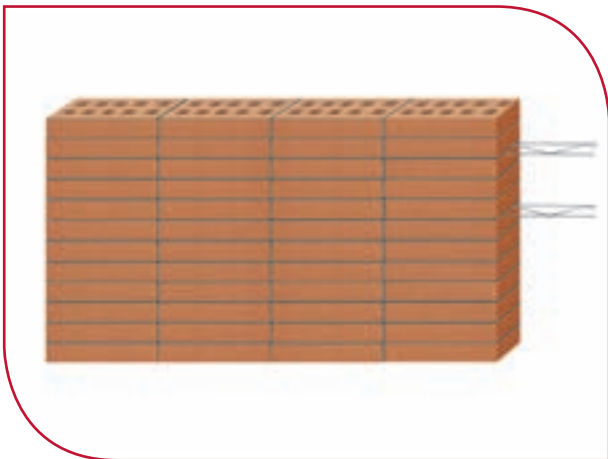

It is possible to construct unbounded walls (in the continuous joints vertically and horizontally) using **fisor®** reinforcement.

- Consult our **technical department** on the specific distribution and amount of reinforcement needed in each case.

2.3 DOUBLE WALLS

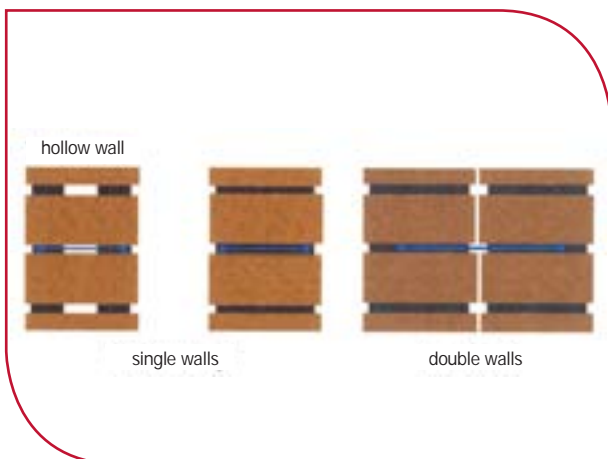

fisor® reinforcement allows the binding of two leaf-walls of a double wall, to get the two walls to work in solidarity. This property is recognized in the Eurocode 6 Part 1-1 (Article 8.5.2.3).

- Consult our **technical department** on the amount and distribution of ties needed in each case.

2.4 LARGE BLOCK CONCRETE WALLS



The use of **fisufor®** reinforcement in concrete block structures allows the elimination of metal hoops and frames by using **geoanc®** anchorages, also possibly eliminating the total or partial need for vertical support pillars (depending on the situation).

For a precise calculation it is essential to contact our **technical department**.

- Consult the specific catalogue.

2.5 INTERIOR PARTITIONS

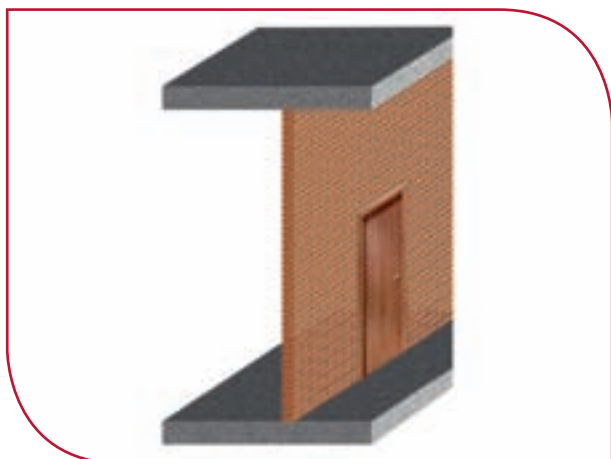

The interior wall and partitions should be calculated to the local lateral force, according to the use of the building.

The use of **fisufor®** reinforcement in thin and tall partitions allows longer distances between supporting pillars and walls.

- Please consult with our **technical department** about the distribution and amount of reinforcement in each case.

2.6 MOVEMENT JOINTS



The use of **fisufor®** reinforcement allows the increase in distance between movement joints.

It is imperative to cut the reinforcement when it passes through joints as to interrupt the continuity and it is recommended to place ties and anchors at such joints.

- Please consult the catalogue **fisufor MT®**.

2.7 EXECUTION OF LINTELS



You should use a beam to secure the opening to ensure the stability of the building.

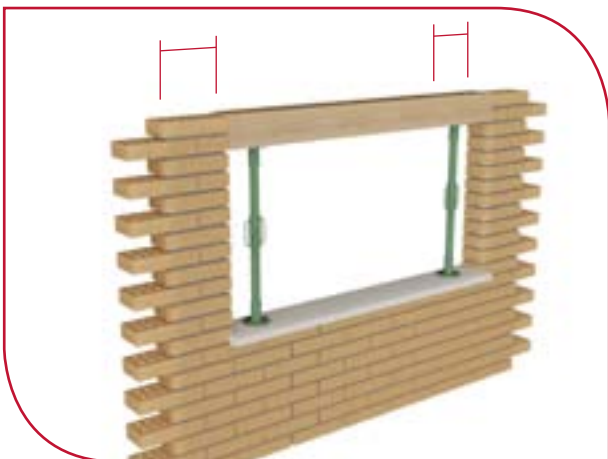

It should be placed with normal rigging masonry, the first row with pieces attached to the shoring beam.



Then place **fisufor**[®] reinforcement on the first row of bricks. It is absolutely imperative that it's installed with at least 50cm of reinforcement exceeding both sides of the opening.



In the vertical joints of the masonry you install **fisufor GD** attached always to one of the transverse wires of **fisufor®** reinforcement.



You can continue to build as normal above the created support. The amount of reinforcement will depend on the edge of the lintel and the length of the opening so you are encouraged to consult with our **technical department** for proper sizing of them.

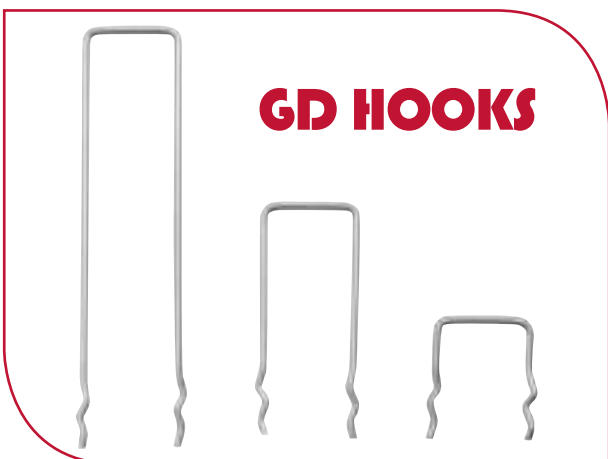

For the proper implementation of lintels it is necessary to use the GD hooks. These elements used in conjunction with **fisufor GD** reinforcement are necessary since without **fisufor®** they do not have any structural function.

These metal elements of stainless steel form a “U” shape whose mission is to ensure the stability of the masonry on the first row of a lintel designed with

masonry reinforcement. In the vertical joints of the structure you install **fisuane GD** attached to one of the transverse wires of **fisufor®** reinforcement.

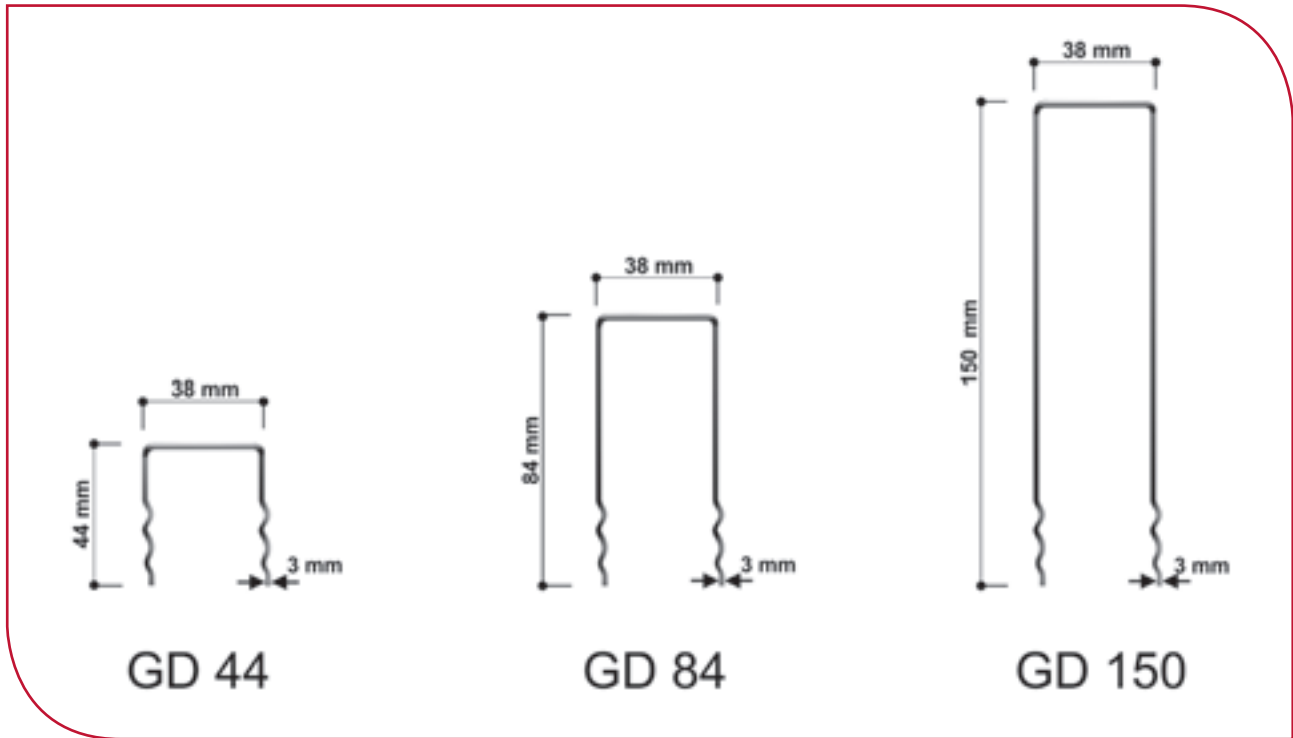

DIMENSIONS OF THE HOOK					
NAME	LENGTH (mm)	Ø WIRE (mm)	WIDTH (mm)	WEIGHT BOX	UNITS BOX
GD 44	44	3	38	0,63 Kg	100
GD 84	84	3	38	1,03 Kg	100
GD 150	150	3	38	1,69 Kg	100

RULES FOR THE IMPLEMENTATION OF THE LINTELS IN THE REINFORCED MASONRY

1. The lintels run with the rigging of the structure.
2. The reinforcement will be installed using the information presented in the manual.
3. The first row of **fisufor®** will have **fisuane GD** through.
4. The installation of the reinforcement should exceed both sides of the opening by at least 50 cm.
5. The beam should be secured for a minimum of 14 days.

COMMON QUESTIONS

1. IS FLATTENED LADDER TYPE REINFORCEMENT THE SAME AS ROUND TRUSS TYPE?

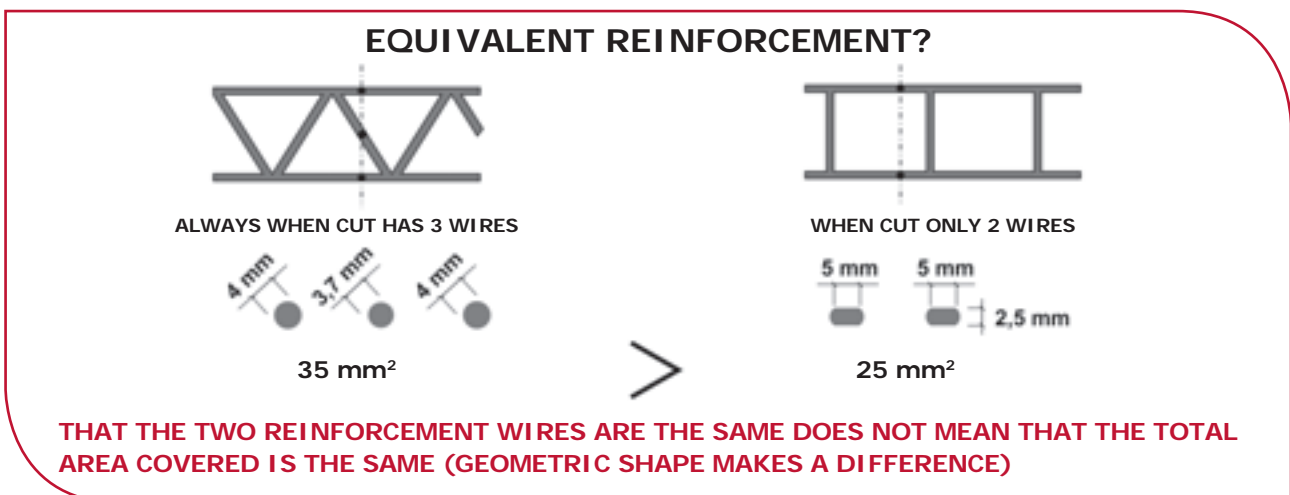
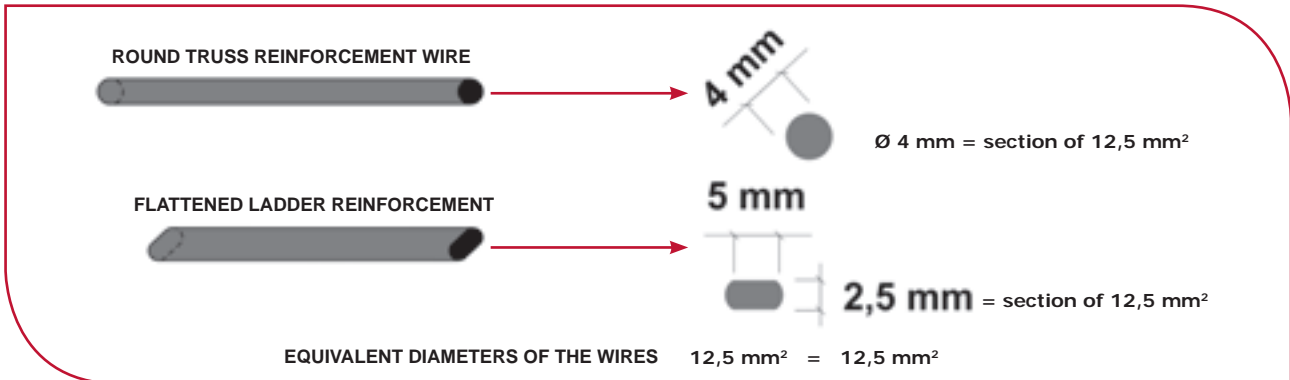

Having the same wire diameter should not be confused with having the same level of reinforcement. When comparing the different types of reinforcement for crack control the calculation for the amount is to do with the surface area of steel facing any vertical section of the wall.

With truss-type reinforcement there are always three wires in contact the entire length, in contrast, in a ladder type you only have two. Therefore to meet the minimum requirements of reinforcement, comparing both types the truss type is needed less in the wall per square metre. Furthermore when the reinforcement is assigned a structural role to withstand lateral side actions the only acceptable geometric configuration is the truss-type, for being the only non-deformable one in its own plane.

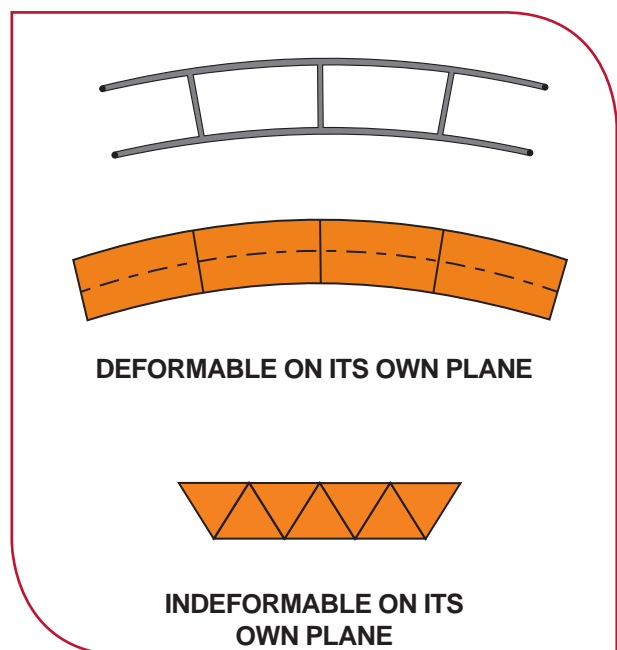

2. DOES AN INCREASE IN THE STRENGTH OF THE STEEL THAT IS USED IN THE REINFORCEMENT IMPROVE THE MECHANICAL BEHAVIOR OF THE WALL?

For control of cracking, the strength of the steel in the reinforcement has no influence on the amount of reinforcement needed, only the area of the cross-section.

When the reinforcement is assigned a structural role, the fact the steel is stronger, does not mean necessarily that you reduce the amount of reinforcement in the same proportions. Because by the requirements of the minimum amount, in the vast majority of cases, steel does not display even half of the resistance. It is the parameter of steel reinforcement which really improves the mechanical performance in the wall, on account of its ductility, not of the resistance. For this reason, to prevent cracking, moving forces with the reinforcement it is preferable that the steel has a high percentage of deformation at failure (that is the parameter which determines ductility) than high resistance.



3. IS THE ADHESION OF THE MASONRY REINFORCEMENT IMPORTANT?

The adhesion of the reinforcement, if you are using the truss-type, does not intervene with the transmission of forces between the first and last node of the truss. The transmission of forces in these sections is performed entirely through the diagonal wires, even without mortar, by virtue of their geometrical configuration, indeformable in their plane.

Where it is really essential for the adherence of transmission of forces between the ends of pieces of reinforcement where the truss ends. This is why the overlap needs, a length proportionate to the forces that are transmitted and adequate cover in the overlap area.

To transfer the maximum force that it can withstand equally in the reinforcement, a sufficient overlap length of 250mm is needed (this value must be verified by tests).

To achieve the adequate transfer of adhesion and forces in the overlap areas, the wires must be spaced when overlapping to a distance equal to their diameter.



4. DOES CORRUGATED WIRE IMPROVE THE ADHESION?

The reinforcement does not improve at all by the fact the wire is corrugated. The conditions for grip relating to transferring forces evenly through-out small-diameter bars, such as the type of masonry reinforcement depend more on the measure of mortar and not the masonry reinforcement.

Grip provided by corrugated bars is only needed when the forces you may have are very large, this only occurs within very thick bars. In the case of the reinforcement a number is worth a thousand words, two bars of 4mm in diameter can transfer securely 10kN, following the required regulations. This value has been tested on smooth bars of reinforcement. Furthermore the calculation shows the real value of the force that is transferred across the reinforcement (that is met by the minimum quantity requirements) in worst case scenarios, is approximately half.

Consequently the corrugated reinforcement makes no extra benefits of reinforcement that weren't in the traditional reinforcement. It is important that the technique of reinforced concrete, capable of transferring large forces, use normal plain bars when there is a small diameter. What really improves the transmission of forces is the existence of a suitable cover of reinforcement in the overlap areas.



Movement joint

5. DOES THE WIDTH OF THE REINFORCEMENT BENEFICIALLY AFFECT THE STRUCTURAL PERFORMANCE?

Reinforcement used in crack control does not require a specific width, since the only thing that counts in this case is the area of steel section.

By contrast, the width of the reinforcement has a role to play when it has a structural function, and that by increasing the mechanical arm, you increase at the same proportion the horizontal bending strength of the walls in the masonry.



Inclining Walls

6. TO IMPROVE THE PERFORMANCE OF MY WALL IN SEISMIC EVENTS, WILL I NEED TO PUT A LOT OF BED JOINT REINFORCEMENT?

For seismic events, the reinforcement itself will improve the mechanical behaviour of the wall because of its ductile properties. However for the same reasons given previously, this cannot be assigned stability of the wall to the reinforcement itself. For the reinforcement to be calculated into seismic effects, it should be accompanied by other elements of retention, such as anchors to the pillars.



Corner Execution

7. AS I HAVE BUILT A VERY HIGH WALL, WILL IT NEED A LOT OF REINFORCEMENT SO IT DOESN'T COLLAPSE?

The reinforcement is not an element of retention, a wall with lots of reinforcement if it is not sufficiently connected to the structure may fall in its entirety. The masonry reinforcement does not provide stability itself.

The reinforcement is there to provide ductility and therefore significantly reducing the risk of cracking. When assigning the reinforcement a mission to structurally support, it is imperative that the wall and support pillars are connected by anchors.



Braceless wall

WORK EXAMPLES



Sports and culture centre in Valladolid (Spain)



Houses in Madrid (Spain)



Houses in Vila Real (Portugal)



Fundoma Building in Asturias (Spain)



Montealbir School in Guadalajara (Spain)



www.steelfb.com

Pol. Ind. El Saco, Parcela, 10
E-50172 Alfajarin, Zaragoza (Spain)
Tel. +34 976 790 640 · Fax: +34 976 100 597
e-mail: export@steelfb.com

Other companies in the GZ Group:



ZFoam

The information and photographs in this booklet are for illustrative purposes only and Steel for Bricks is not responsible for them. The products may be subject to change without prior notice. Any reproduction or replication of any material in this booklet in part or in whole is strictly forbidden without written permission.